

User Manual

MCC4, MCC8, MCC16

MCC4R, MCC8R, MCC16R

MCC8RD, MCC16RD

Raritan Computer Inc.

400 Cottontail Lane
Somerset, NJ 08873
USA
Tel. 1-732-764-8886
Fax. 1-732-764-8887
E-mail: sales@raritan.com
<http://www.raritan.com/>

Raritan Computer Japan, Inc.

4th Flr. Shinkawa NS Building
1-26-2 Shin-kawa, Chuo-ku
Tokyo 104-0033
Japan
Tel. 81-03-3523-5991
Fax. 81-03-3523-5992
E-mail: sales@raritan.co.jp
<http://www.raritan.co.jp>

Raritan Computer France

120 Rue Jean Jaures
93200 Levallois-Perret
France
Tel. 33-14-756-2039
Fax. 33-14-756-2061
E-mail: sales.france@raritan.com
<http://www.raritan.fr>

Raritan Computer U.K. Ltd.

36 Great St. Helen's
London
EC3A 6AP
United Kingdom
Tel. 44 20 7614 7700
Fax. 44 20 7614 7701
E-mail: sales.uk@raritan.com
<http://www.raritan.com>

Raritan Computer Europe, B.V.

Eglantierbaan 16
2908 LV Capelle aan den IJssel
The Netherlands
Tel. 31-10-284-4040
Fax. 31-10-284-4049
E-mail: sales.europe@raritan.com
<http://www.raritan.com/>

Raritan Computer Taiwan, Inc.

5F, 121, Lane 235,
Pao-Chiao Rd., Hsin Tien
Taipei Hsien
Taiwan, ROC
Tel. 886-2-8919-1333
Fax. 886-2-8919-1338
E-mail: sales.asia@raritan.com
<http://www.raritan.com.tw>

Raritan Computer Deutschland GmbH

Lichstraße 2
D-45127 Essen
Germany
Tel. 49-201-747-9820
Fax. 49-201-747-9850
E-mail: sales.germany@raritan.com
<http://www.raritan.de>

Shanghai Representative Office of Raritan Computer, Inc.

RM 19C-1 Shanghai Shiye Building
18 Caoxi North Road
Shanghai China 2000030
Tel. 86-21-64680475
Fax. 86-21-64627964
E-mail: sales.asia@raritan.com
<http://www.raritan.com.tw/>



Copyright ©2008 Raritan Computer, Inc.

MCC-0F-E

June 2008

255-80-3100



FCC Information

This equipment has been tested and found to comply with the limits for a Class A digital device, pursuant to Part 15 of the FCC Rules. These limits are designed to provide reasonable protection against harmful interference in a commercial installation. This equipment generates, uses, and can radiate radio frequency energy and if not installed and used in accordance with the instructions, may cause harmful interference to radio communications. Operation of this equipment in a residential environment may cause harmful interference.

Trademark Information

Product names mentioned in this document are trademarks or registered trademarks of their respective companies. MasterConsole, and its respective logos are registered trademarks of Raritan Computer, Inc. PS/2, RS/6000, and PC/AT are registered trademarks of the International Business Machines Corporation. Mac is a registered trademark of Apple Computer, Inc. Sun is a registered trademark of Sun Microsystems. Alpha is a registered trademark of Digital Equipment Corporation. HP9000 is a registered trademark of Hewlett Packard. SGI is a registered trademark of Silicon Graphics, Inc.

Japanese Approvals

この装置は、情報処理装置等電波障害自主規制協議会（VCCI）の基準に基づくクラスA情報技術装置です。この装置を家庭環境で使用すると電波妨害を引き起こすことがあります。この場合には使用者が適切な対策を講ずるよう要求されることがあります。

*For assistance in the U.S., please contact the Raritan Technical Support Team
at (732) 764-8886 or e-mail us at tech@raritan.com.*

Ask for Technical Support – Monday through Friday, 8:00am to 8:00pm, EST.

For assistance outside the U.S., please contact your regional Raritan office.

This page intentionally left blank.

Contents

CHAPTER 1: INTRODUCTION	1
MasterConsole II Overview	1
Product Photos.....	1
Product Features	2
CHAPTER 2: INSTALLATION	1
Getting Started	1
Quick-Start Operation:	1
One-Tier and Two-Tier Configurations.....	2
CHAPTER 3: ONE-TIER CONFIGURATION	3
Installation.....	3
Configuration	5
Assigning Names and Scan Rates	6
Using MasterConsole II Security Feature	7
Passwords	7
Turning Security on/OFF and Changing Passwords:.....	7
Operation: Using On-Screen User Interface (OSUI)	8
Selecting a Computer	8
Setting AutoScan.....	9
Operation: Using Front Panel Buttons.....	9
CHAPTER 4: TWO-TIER CONFIGURATION	11
Installation.....	12
Install Base Unit (First-Tier) MasterConsole II	12
Connect Second-Tier MasterConsole(s) to the Base Unit.....	13
Connect Computers to Second-Tier MasterConsole(s).....	13
Configuration	13
Assigning Names and Scan Rates	16
Using MasterConsole II Security Features	18
Operating MasterConsole II	18
Selecting a Computer	18
CHAPTER 5: REMOTE ACCESS USING CAT5 REACH	21
APPENDIX A: SPECIFICATIONS	23
Main Unit.....	23
Desktop Model.....	23
Rackmount Model	23
Rackmount 48 Volt DC Model	23
Universal Cable Kits.....	23
Accessories	24
Remote Access Kit	24
APPENDIX B: SYSTEM DEFAULT SETTINGS	25
APPENDIX C: ON-SCREEN USER INTERFACE FUNCTION KEYS	27
APPENDIX D: MASTERCONSOLE II CONFIGURATIONS	29
Programming MasterConsole II at Power Up.....	29
MasterConsole II Product Design Background and Considerations	29
Programming MasterConsole II.....	29

MasterConsole II Configuration Diagrams.....	30
APPENDIX E: GLOSSARY	33
APPENDIX F: TROUBLESHOOTING	35

Table of Figures

Figure 1 MCC4 – Front and Rear Views	1
Figure 2 MC8 – Front and Rear Views	1
Figure 3 MCC16 – Front and Rear Views	2
Figure 4 One-Tier Configuration.....	2
Figure 5 Two-Tier Configuration (with optional Remote Access).....	2
Figure 6 MasterConsole II Rear Panel	3
Figure 7 One-Tier Configuration Cabling Detail	3
Figure 8 Cable Adapters to Convert PS/2 to AT	4
Figure 9 MasterConsole II Front Panel	4
Figure 10 MasterConsole II Front Panel Channel Lights	4
Figure 11 Configuration Menu	5
Figure 12 Edit Names and Scan Rate Menu (One-Tier)	6
Figure 13 Administration Menu.....	7
Figure 14 Selection Menu (One-Tier, sorted by Channel ID).....	8
Figure 15 MasterConsole II Front Panel	9
Figure 16 MasterConsole II Front Panel Channel Lights	9
Figure 17 Two-Tier Configuration (with optional Remote Access Kit).....	11
Figure 18 MasterConsole II Rear Panel	12
Figure 19 Two-Tier Configuration Cabling Detail	12
Figure 20 Configuration Menu (Two-Tier)	14
Figure 21 Device Types.....	14
Figure 22 Device Field.....	14
Figure 23 Default MasterConsole II Channel IDs and Names	16
Figure 24 Edit Names and Scan Rate Menu (Base MasterConsole II).....	16
Figure 25 Edit Names and Scan Rate Menu (Second-Tier MCC8)	17
Figure 26 Selection Menu (Two-Tier, Base MasterConsole II)	18
Figure 27 Selection Menu (Two-Tier, Second Tier Unit).....	18
Figure 28 Remote Access with Cat5 Reach.....	21
Figure 29 Two-Tier Configuration with Satellite Unit.....	21
Figure 30 Basic One-Tier Configurations	30
Figure 31 One-Tier with Remote Access Kit	30
Figure 32 Two-Tier Configuration of up to 256 Computers.....	31
Figure 33 Two-Tier Configuration with MasterConsole P Model.....	31
Figure 34 Two-Tier Configuration with Satellite Unit.....	32

Chapter 1: Introduction

MasterConsole II Overview

Raritan's keyboard/video/mouse (KVM) switches are engineered to provide reliable, cost-effective, central control of multiple computers. This eliminates the cost and clutter of unnecessary equipment, reclaims space, and improves productivity for a host of applications.

MasterConsole II enables control of any mix of 2 to 256 computers from a single keyboard, monitor, and mouse. The MasterConsole II user interface provides simple on-screen control and system management. Raritan's unique emulation technology dedicates a keyboard/mouse emulator for each computer to ensure that each computer always 'sees' its own keyboard and mouse. This means smooth, flawless switching and operation, even when computers are running the most demanding operating systems.

Product Photos



Figure 1 MCC4 – Front and Rear Views



Figure 2 MC8 – Front and Rear Views



Figure 3 MCC16 – Front and Rear Views

Product Features

- MCC Models available for 4, 8, or 16 computers
- “Keep-alive” emulation ensures non-stop computer operation in the event of power loss to the switch
- High-resolution video – 1600 x 1200
- Tangle-proof, double-shielded coaxial cable in lengths from 2 to 30 feet
- On-screen user interface for simple control and system management
- Provision to mix any brand PCs, Macs, Suns, Alphas, RS/6000s, HP9000s, SGIs
- Name assignment availability for quick identification and selection
- Operation from either front panel buttons or hot-keys with on-screen menus
- AutoScan function to view other computers at variable rates
- Cascading from a multi-user MasterConsole MX4
- AutoSkip function provided to bypass inactive channels
- Password Security to ensure authorized access to computers
- Optional Dual Remote access capability with Cat5 Reach
- Compatibility with MasterView-ready MasterConsole P Models (MCPn)
- Two year warranty for parts and labor

Chapter 2: Installation

Getting Started

MasterConsole II is designed for quick, easy installation and operation. Follow the steps for either one-tier or two-tier configuration to be up and running within minutes:

1. Install MasterConsole II (connect computers).
2. Configure MasterConsole II.
3. Assign computer names and set channel-specific scan rates for attached computers.
4. Turn ON security and change passwords to restrict access to computers connected to MasterConsole II.
5. Operate using On-Screen User Interface or front panel buttons.
6. Install optional Cat5 Reach for remote console or satellite unit.

Quick-Start Operation:

After you connect computers to your MasterConsole II you may wish to explore MasterConsole II operation with the default names and parameters.

You may operate using the front panel buttons and/or the On-Screen User Interface. To activate On-Screen User Interface, press the <**Scroll Lock**> key twice rapidly. The Selection Menu will appear. To select a computer, use the <↑> (up arrow) /<↓> (down arrow) keys to highlight the desired channel (computer) and press <Enter> or press the desired computer's Key number (located in the left-hand column). To select another computer, use front panel buttons or re-activate the On-Screen User Interface.

One-Tier and Two-Tier Configurations

MasterConsole II can be configured in one or two tiers, depending on the number of computers you want to control. In a one-tier configuration, only computers are connected to a single MasterConsole II unit. In a two-tier configuration, either a computer or another MasterConsole II unit is connected to each channel of the base MasterConsole II unit.

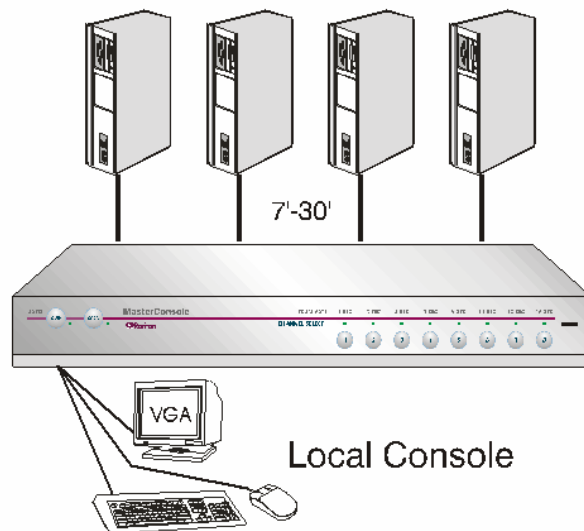

Figure 4 One-Tier Configuration

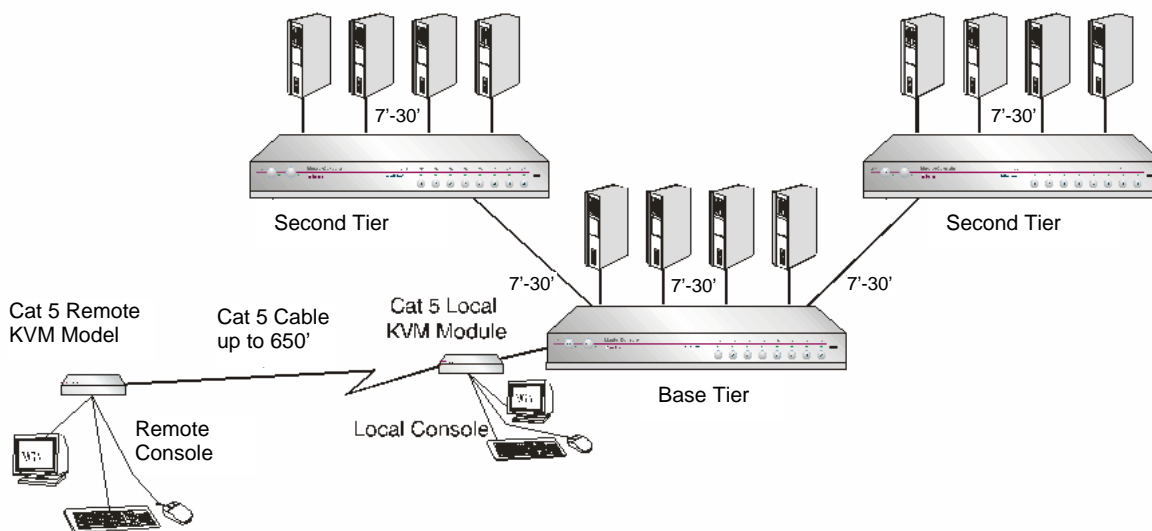

Figure 5 Two-Tier Configuration (with optional Remote Access)

Chapter 3: One-Tier Configuration

Installation

1. Shut down and power OFF all computers to be connected to MasterConsole II.
2. Plug a keyboard, monitor, and mouse into the keyboard, monitor, and mouse ports on the rear panel of the MasterConsole II.

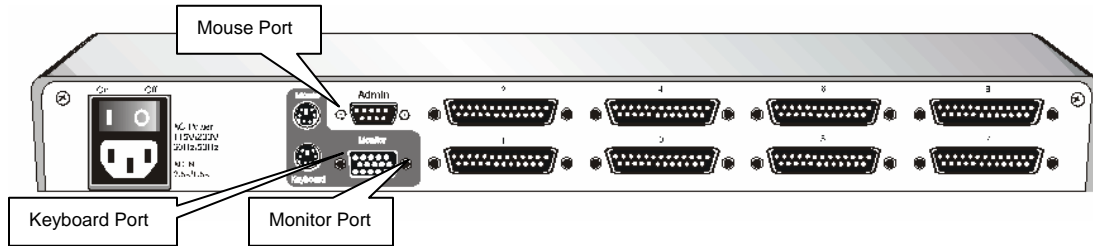

Figure 6 MasterConsole II Rear Panel

3. Power ON the MasterConsole II.
4. Using a universal cable kit (CCPTnn), plug the 25-pin connector into one of the numbered channels on the MasterConsole II back panel.
5. Plug the cable's other connectors into the computer's keyboard, monitor, and mouse ports, using the supplied adapters for AT style PCs.

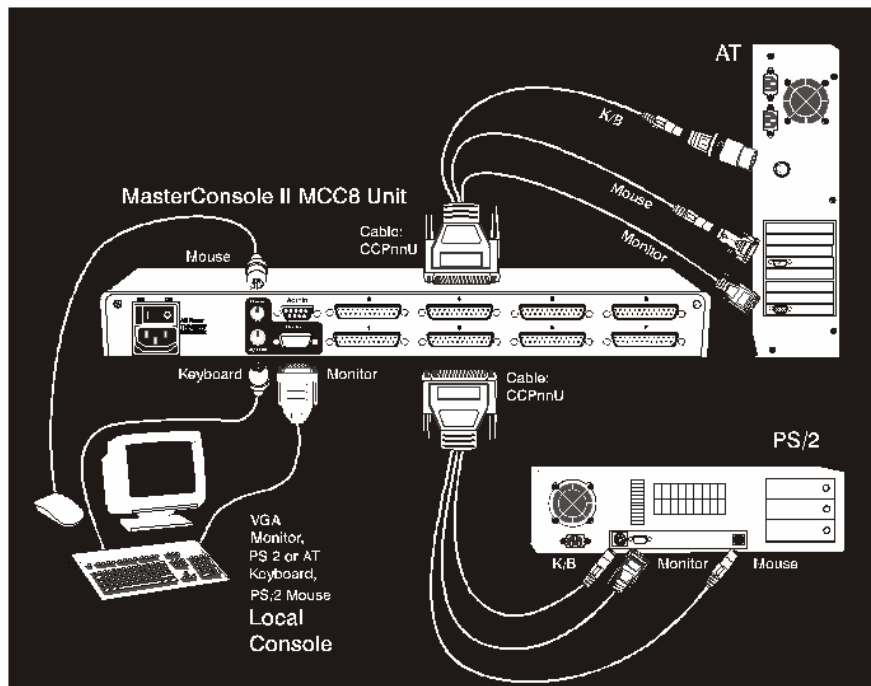

Figure 7 One-Tier Configuration Cabling Detail

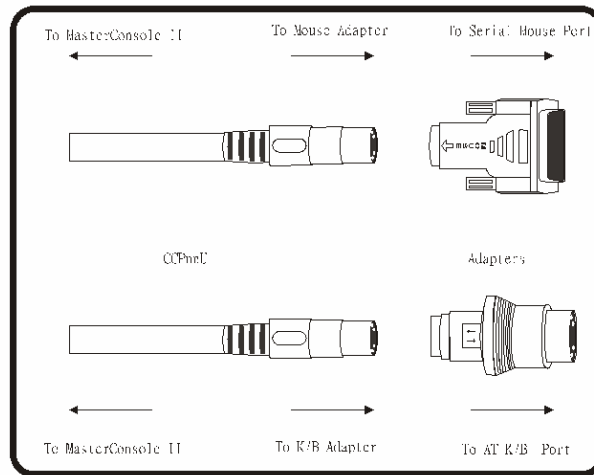

Figure 8 Cable Adapters to Convert PS/2 to AT

6. Power ON the connected computer.
7. Select the connected computer by pressing the corresponding front panel button. Verify that the monitor attached to MasterConsole II displays the video for the connected computer. Use the keyboard and mouse attached to MasterConsole II to verify that they operate the connected computer.

Note: An amber channel light above a numbered channel button on the MasterConsole II front panel indicates that the channel is active; that is, a computer is connected and powered on. A green light above a numbered channel button indicates the currently displayed channel.

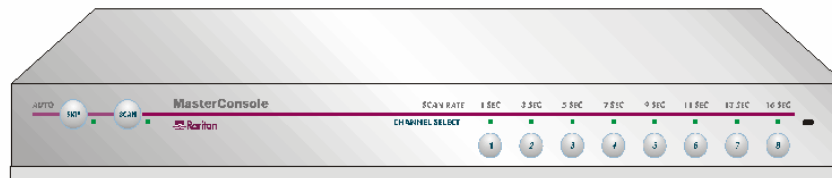

Figure 9 MasterConsole II Front Panel

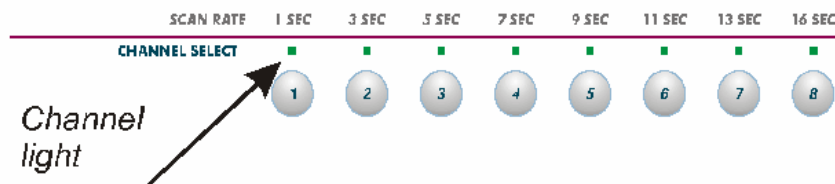

Figure 10 MasterConsole II Front Panel Channel Lights

8. Repeat steps 4 through 7 to connect the remaining computers to MasterConsole II.

Configuration

The Configuration Menu is used to specify your MasterConsole II configuration and to set/change operation parameters.

1. Activate on-screen user interface by pressing the hot-key (<**Scroll Lock**> by default) twice rapidly.
2. Press <**F4**> to access the Configuration Menu.

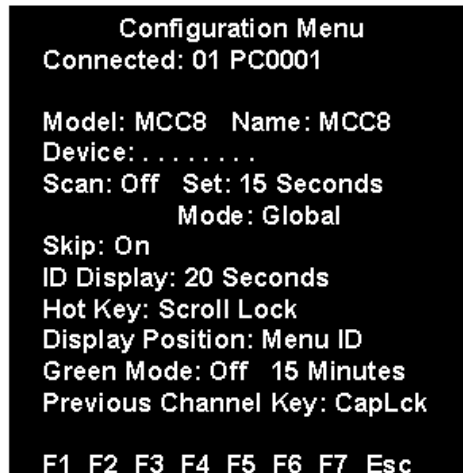

Figure 11 Configuration Menu

- a. The Connected field displays the Channel ID and Name of the currently selected computer.
- b. The Model field displays the model number of this MasterConsole unit.
3. Use the <**Tab**> (forward)/<**Shift**> + <**Tab**> (backward) keys to highlight the desired field and make your changes as follows:
 - a. To change Name (default is the unit's model number): Move to Name and type a name up to five characters. This field is used for your identification purposes only.
 - b. The Device field specifies the type of device connected to each channel. The default character is ".", which indicates that the device is a computer. In a one-tier configuration, only a computer may be connected to each channel. The Device field settings may be changed when expanding to a two-tier configuration.
 - c. To turn AutoScan ON/OFF (default is OFF): Move to Scan and press the <↑>/<↓> keys to toggle. If you exit On-Screen User Interface with AutoScan ON, MasterConsole II will scan according to the currently set mode (Individual/Global) and scan rate.
 - To change the Global Scan Rate (default is 3 seconds): Move to Set and type a number from 01 to 99, or press the <↑>/<↓> keys to specify the Scan Rate (in seconds) for Global AutoScan.
 - To change AutoScan mode (default setting is Global): Move to Mode and press the <↑>/<↓> keys to toggle between Global and Individual. See page 34 for description.
 - d. To turn AutoSkip ON/OFF (default is OFF): Move to Skip and press the <↑>/<↓> keys to toggle. With AutoSkip ON, only active channels can be selected.
 - e. To change the ID Display time interval (default is 3 seconds): Move to ID Display and type a number from 01 to 99, or press the <↑>/<↓> keys to specify the interval (in seconds) you want the Channel ID and Name to display when each computer is selected. Type 99 if you want the Channel ID and Name to display continuously.
 - f. To change the On-Screen User Interface activator (default is <**Scroll Lock**>): Move to Hot Key and press the <↑>/<↓> keys to select the desired key. The hot-key can only be <**Scroll Lock**> <**Num Lock**>, <**Caps Lock**>, left <**Shift**> or left <**Alt**>.
 - g. To change the menu Display position: Move to Menu and press the <**Enter**> key. Then press the <↑>, <↓>, <←>, and <→> keys to move the menu vertically and horizontally to the desired position. Then press <**Esc**> or <**Enter**>.

- h. To change the channel ID display position: Move to ID and press <Enter>. Then press the <↑>, <↓>, <←>, and <→> keys to move the menu vertically and horizontally to the desired position. Then press <Esc> or <Enter>.
- i. To turn PowerSave On/Off (default is OFF): Move to Green Mode and press the <↑>/<↓> keys to toggle. To change the PowerSave delay time (default is 15 minutes): Move to the next field and type a number from 01 to 99, or press the <↑>/<↓> keys to change the interval (in minutes) of inactivity (no keyboard or mouse operation) after which the video signal will be cut off from the monitor. This will allow a properly equipped monitor to enter low-energy mode.
- j. To select Previous Channel Toggle (default is <Caps Lock>). This feature enables the user to toggle between the previous and current selected channel. Press F4 to display the Configuration menu and move the cursor to the Previous Channel Key. Use the <-> or <~> keys to select the key, <Caps Lock>, <Scroll Lock>, <Num Lock>, left <Shift>, or left <Alt> to be used. This feature enables the user to switch back to a previous channel by pressing the selected key twice rapidly. There is no need to activate the OSUI.

Note: Select a previous channel key that is not being used as the current hot key activator.

4. To exit the Configuration Menu: Press an appropriate Menu F key to go to another menu, or press <Esc> to exit on-screen user interface and return to normal computer operation. Any changes made to the Configuration Menu are automatically saved.

Assigning Names and Scan Rates

You may assign meaningful names to quickly and easily identify and select connected computers. By default, the channel name is PC00aa (where **aa** is the channel ID number) and the Channel-Specific Scan Rate is 3 seconds.

1. Activate On-Screen User Interface.
2. Press <F3> to access the Edit Names and Scan Rate Menu.

Edit Names and Scan Rate						
MC: MCC8				Page: 1 / 1		
Ch. ID	Name	Scan Rate				
01	PC0001	05				
02	Sara	03				
03	Sales-2	10				
04	Bob	04				
05	PC0005	06				
06	PC0006	08				
07	Market-4	03				
08	JoePC	02				
F1	F2	F3	F4	F5	F6	F7 Esc

Figure 12 Edit Names and Scan Rate Menu (One-Tier)

3. Use the <Tab>, <Shift+Tab> or <↑>/<↓> keys to move the cursor to the line you want to edit. Use <←>/<→> to move within a line.
 - a. To change the Name: Type up to 8 characters (no spaces).
 - b. To change the Channel-Specific Scan Rate (default is 3 seconds): Type a number from 00 to 99 (seconds). When the AutoScan Mode in the Configuration Menu is set to Individual, these Channel-Specific Scan Rates are enabled. If the AutoScan mode is set to Global, the global value will be used.
4. When you move to a different page or exit this Menu, you are prompted to save your changes. Press <Y> to save.
5. To exit the Edit Names and Scan Rate Menu: Press any Menu F key to go to another menu, or press <Esc> to go to the Selection Menu.

Note: If your MasterConsole II is a 16-channel model, MCC16, use the <Page Up>/<Page Down> keys to view the next or previous group of eight channels.

Using MasterConsole II Security Feature

You can restrict access to MasterConsole II. The Administration Menu is used to turn security on/OFF and to change the Administrator's Password and the five authorized user passwords. Up to six passwords can be defined - one Administration Password and five User Passwords.

Note: If security is ON, and the system remains idle (no keyboard, mouse, or front panel operation for a time interval set by the user-default is 15 minutes), the next user must enter a user password to establish access. By default, MasterConsole II operates with security OFF.

Passwords

Only the Administrator's password provides access to the Administration Menu, which is accessed to turn security on/off and to change passwords. If you use the security feature, be sure to record and store passwords where they will be handy to you and other authorized users.

MasterConsole II is delivered with system default passwords. They are:

USER	PASSWORD
Admin	Raritan
User 1	111
User 2	222
User 3	333
User 4	444
User 5	555

Turning Security on/OFF and Changing Passwords:

1. Activate On-Screen User Interface.
2. Press <F5> to access the Administration Password prompt.
3. Type in the Administration Password and press the <Enter> key.
4. The Administration Menu will be displayed.



Figure 13 Administration Menu

5. Use the <Tab> key to move the cursor forward or use the <Shift-Tab> key combination to move the cursor back to the desired field and make your changes as follows:
 - a. To turn Security ON/OFF (default is OFF): Press the <↑>/<↓> keys to toggle.
 - b. To change Security activation delay time (default is 15 minutes). Move to the Time Out field, then type a number from 01 to 99, or use the <↑>/<↓> keys to specify a time

- interval. If the system will remains inactive (no keyboard or mouse operation) for this time interval, the next user is required to enter a password to access the MasterConsole II.
- c. To change the Administration Password: Move to Change Passwords, where Admin will be highlighted. Press the <Enter> key and type a new password (up to eight alphanumeric characters, no spaces). Press <Enter>. Confirm the password by typing it again. Press <Enter>.
 - d. To change a User Password, press the <Tab> key to highlight one of the desired Users. Press <Enter>. Type a new password (up to eight alphanumeric characters, no spaces). Press <Enter>. Confirm the password by typing it again. Press <Enter>. Repeat this process for the remaining four Users, pressing the <Tab> key to move from one User field to the next. You can specify up to five User Passwords.
 - e. To change the type of keyboard, press the <Tab> key to highlight Language Mode field. Press <↑>/<↓> to select English, German, or French.
6. To exit the Administration Menu: Press any Menu F (function #) key to go to another menu or press <Esc> to exit on-screen user interface and return to normal computer operation.

Operation: Using On-Screen User Interface (OSUI)

Selecting a Computer

1. Activate on-screen user interface by pressing the hot-key twice rapidly.
 - a. AutoScan is suspended, if set.
 - b. MasterConsole II front panel buttons are disabled.
 - c. The Selection Menu is displayed.

Selection Menu			
MC: MCC8	Page: 1 / 1		
Key	Ch ID	Name	Status
.....
1	01	PC0001	+S05
2	02	Sara	+S03
3	03	Sales-2	+S10
4	04	Bob	+S04
5	05		-S06
6	06		-S08
7	07	Market-4	+S03
8	08	JoePC	+S02
.....
F1	F2	F3	F4
F5	F6	F7	Esc

Figure 14 Selection Menu (One-Tier, sorted by Channel ID)

2. The Selection Menu lists channels sorted either by Channel ID or alphabetically by Name. Default sorting is by Channel ID. Press <F12> to toggle between Channel ID and alphabetical.
 - a. The Selection Menu displays a maximum of eight channels at a time.
 - b. The Status column shows each channel's activity and Channel-Specific Scan Rate. A "+" in the first column indicates a device is connected and powered ON, while a "-" indicates the device is powered OFF or there is no device connected. "Snn" indicates the Channel-Specific Scan Rate of nn seconds. (default is 3 seconds).
 - c. As the computer status changes (active/inactive), the MCC updates the Status column periodically. To enable a user to see the new status immediately, activate the OSUI and press F8-Upgrade Computer Status. The MCC will scan the channels and update the computer status and then return to the previous menu.
 - d. For any inactive channel, the ID bar will display only the channel ID and not the name field, when sorted by channel and will not display anything when sorted by name-F12 toggle.
 - e. The non-displayed names are still available in the MCC internal database and can be edited with the F3 function.

3. To select a computer:

- Use the <Page Up>/<Page Down> or <↑>/<↓> keys to highlight the desired computer and press <Enter>

OR

- When the Selection Menu is sorted by Channel ID, press the desired computer's Key number (shown in the left-hand column);

OR

- When the Selection Menu is sorted by name (arranged alphabetically), use the <Page Up>/<Page Down> or <↑>/<↓> keys, or type the first character(s) of the desired Name to quickly jump to the Name that most closely matches what you type. To back up a character, press the <Backspace> key. Highlight the desired computer, and press <Enter>.
 - When you select a computer, you automatically return to normal computer operation at the selected computer.
 - The light above the selected Channel button turns from amber to green, and the monitor displays video from the selected computer.
 - The Channel ID and Name will be displayed on the monitor for the time interval specified in the Configuration Menu.
 - Press <Home> at any time to return to the first page of the Configuration Menu (for 16-channel or two-tier systems).

Note: See Appendix X for a list of other Function Keys and how to use them.

Setting AutoScan

AutoScan activation shortcut: Activate the On-Screen User Interface and press the <F6> Key. The green light next to the <Scan> button on the front panel will be ON and the unit will scan according to the parameters set in the Configuration Menu.

Operation: Using Front Panel Buttons

When the on-screen user interface is not activated, you can operate MasterConsole II from the front panel.

The front panel has a [Scan] button, a [Skip] button, and a series of numbered buttons used to select channels and to set the Global scan rate.

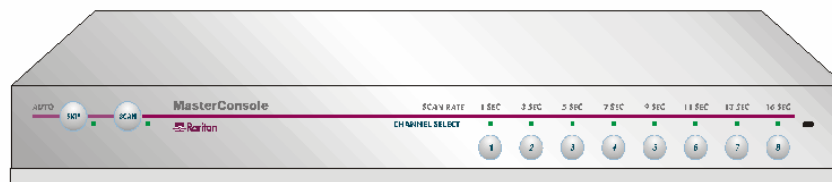

Figure 15 MasterConsole II Front Panel

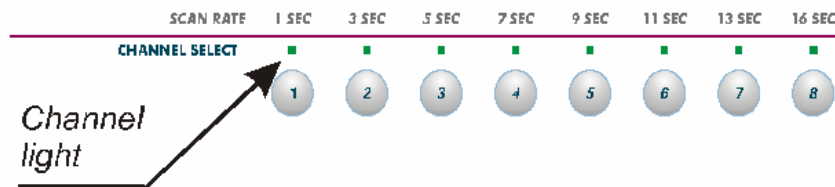

Figure 16 MasterConsole II Front Panel Channel Lights

1. To select a computer:

- Be sure the green light next to the [Scan] button is OFF (toggle ON/OFF).
- Press the numbered button corresponding to desired channel.

- c. The light above the selected Channel button turns green, video from the selected computer displays on screen and you may now operate the selected computer.
 - d. The Channel ID and Name will be displayed on the screen for the time interval specified in the Configuration Menu.
2. To activate AutoScan, press the [**Scan**] button (toggle ON/OFF) The green light next to the [**Scan**] button will be ON and the unit will scan according to the parameters set in the Configuration Menu. If the AutoScan Mode is set to Individual, AutoScan will occur at the Channel-Specific Scan Rates as defined in the Edit Names and Scan Rate Menu.
3. To change the scan rate, while AutoScan is ON, press the numbered button corresponding to the desired Scan Rate located above the front panel channel light to set the Global Scan Rate. If the Scan Mode in the Configuration Menu had been previously set to Individual, it will be reset to Global after the front panel button is pressed.
4. To activate AutoSkip, press the [**Skip**] button (toggle ON/OFF). The green light next to the [**Skip**] button will be ON and only active channels will be selected.

Chapter 4: Two-Tier Configuration

You may cascade MasterConsole II units to create a two-tier configuration. In a two-tier configuration, a mix of devices – computers and MasterConsoles – may be connected to the channels of the first tier-referred to as the base MasterConsole II.

The second-tier MasterConsole may be any combination of MasterConsole IIs, or MasterConsole P Models, which may be banked. Only computers may be connected to the channels of the any second-tier MasterConsole.

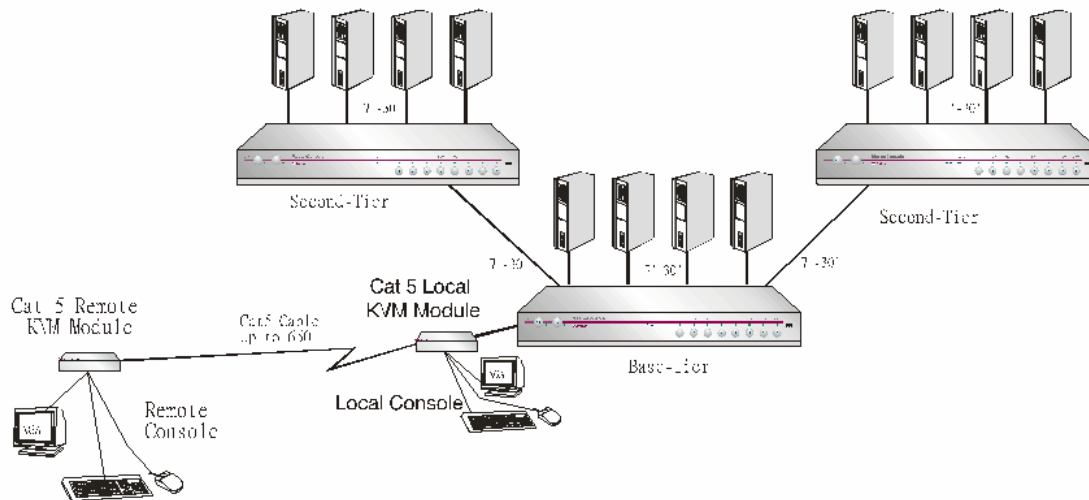

Figure 17 Two-Tier Configuration (with optional Remote Access Kit)

Installation

Install Base Unit (First-Tier) MasterConsole II

1. Plug the keyboard, monitor, and mouse into the keyboard, monitor, and mouse ports on the MasterConsole II back panel.

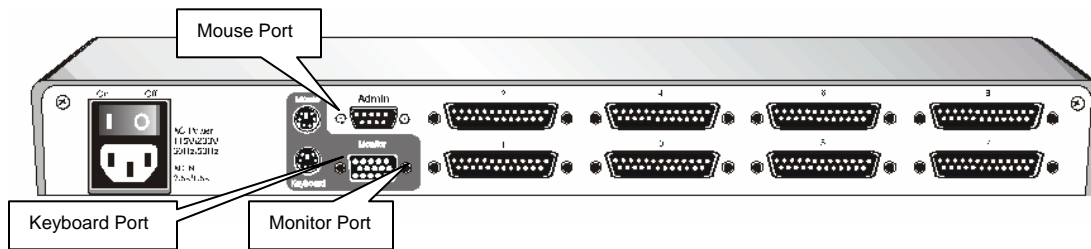

Figure 18 MasterConsole II Rear Panel

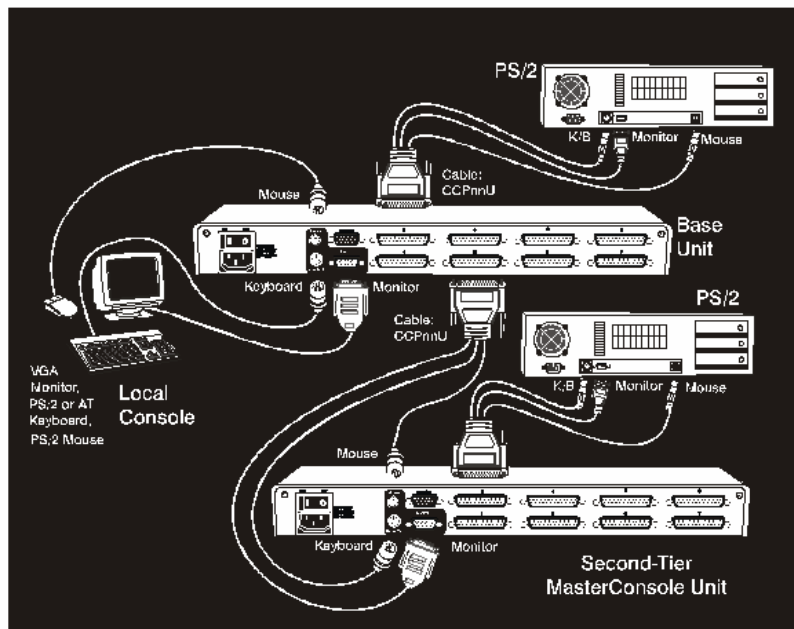

Figure 19 Two-Tier Configuration Cabling Detail

2. Power on the MasterConsole II base unit.
3. Connect computers to any Channels on the base MasterConsole II back panel.
 - a. Shut down and power off all computers to be connected to the base MasterConsole II.
 - b. Using a Universal cable kit (CCPTnn), plug the 25-pin connector into one of the numbered Channels on the base MasterConsole II back panel.
 - c. Plug the cable's other connectors into the computer's keyboard, monitor, and mouse ports. Use supplied adapters for AT style PCs.
 - d. Power ON the connected computer.
 - e. Select the connected computer by pressing the corresponding front panel button. Verify that the monitor attached to MasterConsole II displays the video for the connected computer. Use the keyboard and mouse attached to the base MasterConsole II to verify that they operate the connected computer.
 - f. Repeat steps 3.a through 3.e to connect additional computers to the base MasterConsole II.

Connect Second-Tier MasterConsole(s) to the Base Unit

1. Connect MasterConsole(s) to any Channel(s) of the base MasterConsole II.
 - a. Using a Universal cable kit (CCPTnn), plug the 25-pin connector into one of the numbered Channels on the base MasterConsole II back panel.
 - b. Plug the cable's other connectors into the Keyboard, Monitor, and Mouse ports of the second-tier MasterConsole II or MasterConsole P Model.
 - c. Power on the MasterConsole unit according to the following instructions:

Note: All second-tier MasterConsole P Models must be MasterView ready. To determine if your P Model does have this feature, check the white label on the bottom of the unit *. This label shows the unit's level and style of firmware: MDSP-nnn. If it is MDSP-1AC or higher (MDSP-1AD, etc.), the unit is MasterView ready. If not, you need to upgrade. Call Raritan Technical Support for details.

IMPORTANT: For MasterConsole II, the unit must be programmed as a second-tier unit. (The default setting is first-tier) To program any MasterConsole II as a second-tier unit, power ON while pressing the Channel #2 button on the front panel and hold for 3 seconds. When the unit is programmed as a second-tier unit, the LED on the far right of the unit's front panel (2ND) will be lit continuously. Note: Any unit can be re-programmed to be a first-tier unit by pressing the Channel #1 button on the front panel during a subsequent power ON process.

For MasterConsole P Model: Turn the power switch on.

1. Repeat steps 4a through 4c to connect additional second-tier MasterConsole units to the base MasterConsole II.
2. For second-tier units located more than 30 feet away from the base unit, see Remote Access Using Cat5 Reach, page 25.

Connect Computers to Second-Tier MasterConsole(s)

Connect computers to the channels of second-tier MasterConsole(s).

1. Follow Steps 3a through 3f to connect the computers to each second-tier MasterConsole II.
2. For MasterConsole P Models, follow installation instructions in the P Model manual.

Configuration

The Configuration Menu is used to specify your base MasterConsole II configuration and to set/change parameters for operation.

1. Activate on-screen user interface by pressing the hot-key (<**Scroll Lock**> by default) twice rapidly.
2. Press <**F4**> to access the Configuration Menu.



Figure 20 Configuration Menu (Two-Tier)

- a. The Connected field displays the Channel ID and Name of the currently selected computer.
- b. The Model field displays the model number of this MasterConsole unit (MCCn).
3. Use the <Tab> (forward)/<Shift-Tab> (backward) keys to select the desired field and make your change as follows:
 - a. To change Name (default is the unit's model number): Move to Name and type a name up to five characters. This field is used for your identification purposes only.
 - b. The Device field specifies the type of device computer or MasterConsole connected to each channel of the base MasterConsole II unit. <Tab> to the Device field. You must specify the device for each channel

The Device field consists of a sequence of characters equal to the channel capacity of the base unit. The leftmost character corresponds to the unit's channel 1, while the rightmost character corresponds to the highest channel number.

.	=	computer (default)
For non-computers, define the Device as follows:		
a	=	MCP2
b	=	MCP4
c	=	MCP8
d	=	MCP16
x	=	MCC4, MCS4, MCX4
y	=	MCC8, MCS8, MCX8
z	=	MCC16, MCX16

Figure 21 Device Types

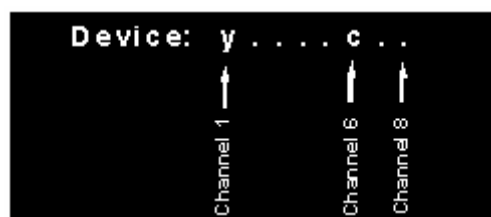

Figure 22 Device Field

For example, the y c . . Device field indicates the following: an 8-channel MasterConsole II MCC8 model is connected to the first channel on the base MasterConsole II, an 8-channel MasterConsole P Model is connected to the sixth channel, and computers are connected (or to be connected) to all other channels.

Note: *If you specify a MasterConsole P Model, a pop-up box will prompt for banking information.*

See One-Tier Configuration for instructions on setting/changing other operational parameters (AutoScan, AutoSkip, ID Display, hot-key, Menu Display, PowerSave).

Assigning Names and Scan Rates

When you specify non-computer devices (MasterConsole units) connected to base MasterConsole II channels, these devices are automatically assigned default names in the base MasterConsole II Selection Menu. In addition, since computers can be connected to each channel of a second-tier MasterConsole, a page is automatically created for each second-tier MasterConsole in the Selection Menu, listing Channel IDs with default names for each channel. These names may be changed using the Edit Names and Scan Rate Menu.

The following are the MasterConsole II default Channel ID and Names for connected devices in a two-tier configuration.

Base MasterConsole II		
Connected Devices	Channel ID	Default Name
computer	aa	PC00aa*
MasterConsole II	aa	/MCCaa*
MasterConsole MCPn	aa	/MCPaa*
* where aa= Channel # of the base MCCn.		
Second Tier		
Computers Connected To	Channel ID	Default Name
MasterConsole II	aa.bb	PCaabb
where aa= Channel # of the base MCCn; and bb= Channel # of the second-tier MasterConsole II		
MasterConsole P Model	aa.Bb-cc	PCaaBbcc
where aa= Channel # of the base MCCn, and b= Bank # and cc= Channel # of the second-tier MCPn		

Figure 23 Default MasterConsole II Channel IDs and Names

To change Names and/or Channel-Specific Scan Rates:

1. Activate On-Screen User Interface.
2. Press <F3> to access the Edit Names and Scan Rate Menu.

Edit Names and Scan Rate						
MC: MCX8				Page: 1 / 3		
Ch. ID	Name	Scan Rate				
01	MCS01	08				
02	PC0002	03				
03	Market-3	10				
04	Jen	04				
05	Vicki	06				
06	MCP06	05				
07	PC0007	03				
08	PC0008	02				
F1	F2	F3	F4	F5	F6	F7 Esc

Figure 24 Edit Names and Scan Rate Menu (Base MasterConole II)

Edit Names and Scan Rate		
MC: MCS01		Page: 2 / 3
Ch. ID	Name	Scan Rate
01.01	PC0101	05
01.02	Sara	03
01.03	Sales-2	10
01.04	Bob	04
01.05	PC0105	06
01.06	PC0106	08
01.07	Market-4	03
01.08	JoePC	02
F1	F2	F3
F4	F5	F6
F7	Esc	

Figure 25 Edit Names and Scan Rate Menu (Second-Tier MCC8)

3. Use the <Tab>, <Shift-Tab> or <↑>/<↓> keys to move the cursor to the line you want to edit. Use <←>/<→> to move within a line.

Note: Because you have specified a two-tier configuration, use the <Page Up>/<Page Down> keys to view the next or previous group of up to eight channels.

- a. To change the Name of a second tier MasterConsole Device in the base unit channel list: Type up to seven alphanumeric characters (no spaces). The "/" (backslash) first character cannot be changed.
 - b. To change the Name of any computer connected to either the base unit or second-tier MasterConsole, type up to eight alphanumeric characters (no spaces).
 - c. To change the Channel-Specific scan Rate for any highlighted channel (default is 3 seconds): Type a number from 00 to 99 (in seconds). When the AutoScan Mode in the Configuration Menu is set to Individual, these Channel-Specific Scan Rates are enabled. If the AutoScan mode is set to Global, the global scan rate will be used.
4. When you move to a different page or exit this Menu, you are prompted to save your changes. Press <Y> to save.
 5. To exit the Edit Names and Scan Rate Menu: Press any Menu F key to go to another menu, or press <Esc> to go to the Selection Menu.

Using MasterConsole II Security Features

Follow instructions for Security in Using MasterConsole II's Security Feature (One-Tier).

Important: You must use the On-Screen User Interface to operate a two-tier configuration. There is no front panel operation available.

Operating MasterConsole II

Selecting a Computer

1. Activate On-Screen User Interface.
 - a. AutoScan is suspended, if set.
 - b. MasterConsole II front panel buttons are disabled.
 - c. The Selection Menu is displayed.

Selection Menu			
MC: MCC8		Page: 1 / 3	
Key	Ch ID	Name	Status
1	01	.MCC01	+S08
2	02	PC0002	+S03
3	03	Market-3	+S10
4	04	Jen	+S04
5	05	Vicki	+S06
6	06	.MCP06	+S08
7	07	PC0007	+S03
8	08		-S02
F1	F2	F3	F4
F5	F6	F7	Esc

Figure 26 Selection Menu (Two-Tier, Base MasterConsole II)

Selection Menu			
MC: MCC01		Page: 2 / 3	
Key	Ch ID	Name	Status
1	01.01	PC0101	.S05
2	01.02	Sara	.S03
3	01.03	Sales-2	.S10
4	01.04	Bob	.S04
5	01.05	PC0005	.S06
6	01.06	PC0006	.S08
7	01.07	Market-4	.S03
8	01.08	JoePC	.S02
F1	F2	F3	F4
F5	F6	F7	Esc

Figure 27 Selection Menu (Two-Tier, Second Tier Unit)

2. The Selection Menu lists channels sorted either by Channel ID or alphabetically by Name. Default sorting is by Channel ID. Press <F12> to toggle.
 - a. The Selection Menu displays a maximum of eight channels at a time.
 - b. The Status column shows each channel's activity and Channel-Specific Scan Rate. A "+" in the base unit's Selection Menu indicates the device is connected and powered ON, while a "-" indicates the device is powered OFF, or there is no device connected. A "." in

- the Status column of the second-tier Selection Menu indicates that the status of the computer is undetermined. Snn indicates the individual Scan Rate of nn seconds.
- c. As the computer status changes (active/inactive), the MCC updates the Status column periodically. To enable a user to see the new status immediately, activate the OSUI and press F8-Upgrade Computer Status. The MCC will scan the channels and update the computer status and then return to the previous menu.
 - d. For any inactive channel, the ID bar will display only the channel ID and not the name field, when sorted by channel and will not display anything when sorted by name-F12 toggle.
 - e. The non-displayed names are still available in the MCC internal database and can be edited with the F3 function.
3. To select a computer:
- Use the <Page Up>/<Page Down> or <↑>/<↓> keys to scroll to the desired computer and press <Enter>

OR

- When the Selection Menu is sorted by Channel ID, press the desired computer's Key number (in the left-hand column)

OR

- a. When the Selection Menu is sorted by name, use the <Page Up>/<Page Down> or <↑>/<↓> keys, or type the first character(s) of the desired Name to quickly jump to a Name that most closely matches what you type. To back up a character, press the <Backspace> key. Highlight the desired computer, and press <Enter>.
- b. When you select a computer, you automatically return to normal computer operation at the selected computer.
- c. The light above the selected Channel button turns green, and the monitor displays video from the selected computer.
- d. The Channel ID and Name will display on the monitor for the time interval specified in the Configuration Menu.
- e. Press <Home> at any time to return to the first channel on the first page of the Selection Menu. Press <End> at any time to advance to the last channel on the last page of the Selection Menu.

Chapter 5: Remote Access Using Cat5 Reach

Raritan's Cat5 Reach can be used to extend the user console up to 650 feet away. Please see the Cat5 Reach manual for installation procedure. The MasterConsole II with Cat5 Reach provides:

- Dual Remote User Console: Remote access point to a base MasterConsole II, plus a local user console.

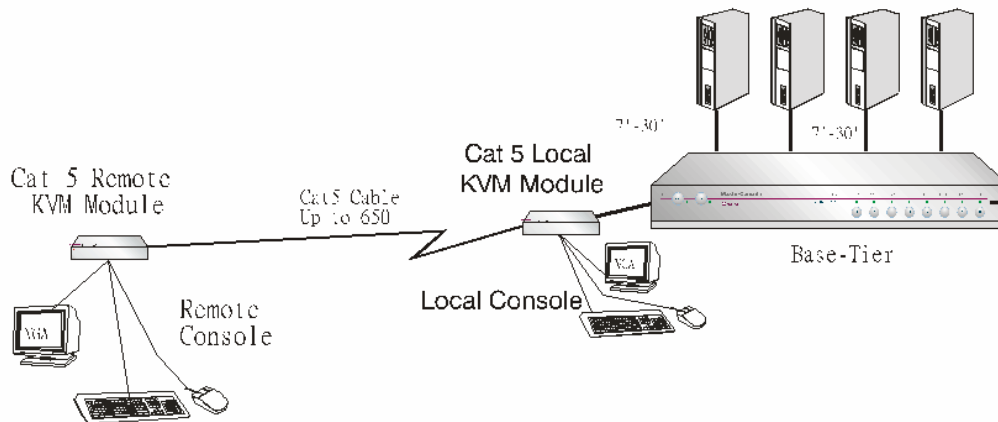

Figure 28 Remote Access with Cat5 Reach

- Satellite Unit: Second-tier MasterConsole located more than 30 feet from the base unit.

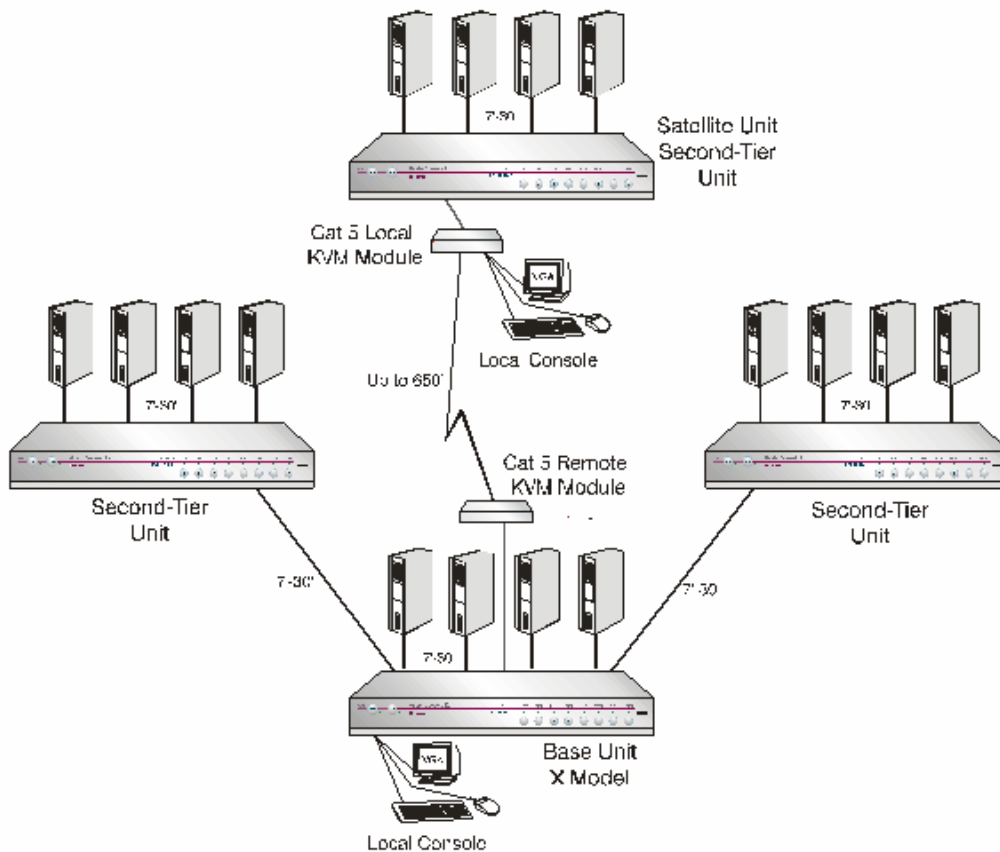

Figure 29 Two-Tier Configuration with Satellite Unit

Appendix A: Specifications

Main Unit

Desktop Model

MCC4 (4-channel model)	10.55"(W) x 9"(D) x 1.75"(H)	2.0 kg (4.5 lbs.)
MCC8 (8-channel model)	15.4"(W) x 9"(D) x 1.75"(H)	2.8 kg (6.1 lbs.)
MCC16 (16-channel model)	15.4"(W) x 9"(D) x 3.5"(H)	3.8 kg (8.4 lbs.)
Power	115V/230V (Auto Sensing) 60 Hz / 50 Hz 0.2A/0.1A	

Rackmount Model

MCC4R (4-channel model)	19"(W) x 9"(D) x 1.75"(H)	3.0 kg (6.66 lbs.)
MCC8R (8-channel model)	19"(W) x 9"(D) x 1.75"(H)	3.77 kg (8.37 lbs.)
MCC16R (16-channel model)	19"(W) x 9"(D) x 3.5"(H)	4.8 kg (10.66 lbs.)
Power	115V/230V (Auto Sensing) 60 Hz / 50 Hz 0.2A/0.1A	

Rackmount 48 Volt DC Model

MCC8RD (8-channel model)	19"(W) x 9"(D) x 1.75"(H)	2.97 kg (6.6 lbs.)
MCC16RD (16-channel model)	19"(W) x 9"(D) x 3.5"(H)	4.52 kg (10.05 lbs.)
Power	48Volt DC +/-0.3A 3W3 male connector Pin out A1 (G), A2 (-), A3 (+)	
Operating Temp.	0-50°C (32-122°F)	

Universal Cable Kits

For each PS/2 Computer (VGA Video, PS/2 K/B, PS/2 Mouse) and AT Computer (VGA Video, AT K/B, Serial Mouse)

Part No.	Length	Connectors
CCPT06	2' (0.6 M)	DB25(M) to HD15(M), 2x mini-DIN6(M)
CCPT20	6.5' (2 M)	DB25(M) to HD15(M), 2x mini-DIN6(M)
CCPT40	13' (3 M)	DB25(M) to HD15(M), 2x mini-DIN6(M)
CCPT60	20' (6 M)	DB25(M) to HD15(M), 2x mini-DIN6(M)
CCPT90	30' (9 M)	DB25(M) to HD15(M), 2x mini-DIN6(M)

Each Universal Cable Kit comes with 2 Adapters for AT keyboard and serial mouse: (1) DIN 6F to DIN 5M, and (1) DIN 6F to DB9F

Accessories

RMCS4 (for 4-channel model) 19" Rack Mount Bracket – 1U
 RMCS8 (for 8-channel model) 19" Rack Mount Bracket – 1U
 RMCS16 (for 16-channel model) 19" Rack Mount Bracket – 2U

PCE60 20' (6 M) Extension Cable for Keyboard, Video, and Mouse
 PCE110 35' (11 M) Extension Cable for Keyboard, Video, and Mouse

Remote Access Kit

See Cat5 Reach Specification Sheet for complete details.

UKVM (Dual Transmitter for Category 5 UTP cable)

Dimensions 4.3" (W) x 3.6"(D) x 1.0" (H)
 108mm (W) x 91mm (D) x 23mm (H)
 Weight 0.5 lbs (0.2 kg)
 Power No external power required
 User Port (local access) 6 pin k/b & mouse, HD15
 Connection to PC/switch Cable kit CCPT06 or CCP10E required

URKVM (Receiver for Category 5 UTP cable)

Dimensions 4.3" (W) x 3.6"(D) x 1.0" (H)
 108mm (W) x 91mm (D) x 23mm (H)
 Weight 0.5 lbs (0.2 kg)
 Power 6V DC input (Adapter included)
 User Port (remote access) 6 pin k/b & mouse, HD15

Note: Category 5 UTP cable with RJ45 connectors must conform to EIA/TIA T568B Category 5 wiring standard.

For highest quality video at distances greater than 200', Category 5 UTP Enhanced (350Mhz bandwidth) cable is recommended.

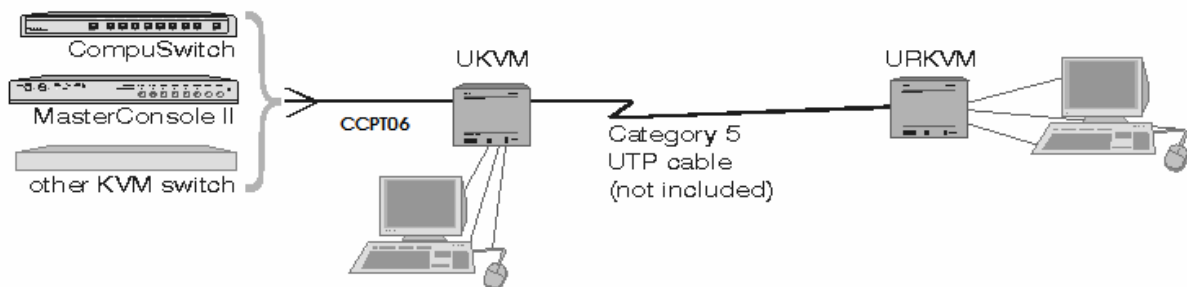

Appendix B: System Default Settings

FUNCTION	SETTING
Administration Password	raritan (case sensitive)
AutoScan	OFF
AutoScan mode	Global
AutoSkip	OFF
Channel-Specific Scan Rate	3 seconds
Device	“.” (computer devices)
Global Scan Rate	3 seconds
Hot Key	<ScrollLock> <ScrollLock>
ID Display Interval	3 seconds
MasterConsole II unit configuration	First tier
PowerSave	OFF
PowerSave delay time (Green Mode)	15 minutes
Remote Time Out interval	3 seconds
Security	OFF
Security activation delay time	15 minutes
Selection Menu sorting	Channel ID
User password	User 1-111
	User 2-222
	User 3-333
	User 4-444

Appendix C: On-Screen User Interface Function Keys

Use the following Function Keys while using On-Screen User Interface:

PRESS...	WHEN YOU WANT TO...
<F1>	Go to the Help Menu; get a list of all the Function keys
<F2>	Go to the Selection Menu; view the list of channels or select a channel
<F3>	Go to the Edit Names and Scan Rate Menu; change channel Names or Individual Scan Rates
<F4>	Go to the Configuration Menu; change operating parameters (on-screen user interface, Menu position, ID position, Global / Individual Scanning, AutoScan OFF/ON, scan rate, AutoSkip OFF/ON, Hot Key, duration of ID display)
<F5>	Go to the Administration Menu; turn Security ON/OFF, change User Passwords
<F6>	Exit On-Screen User Interface and turn ON AutoScan
<Alt>+<F6>	Exit On-Screen User Interface and turn OFF AutoScan
<F7>	Exit On-Screen User Interface and turn ON AutoSkip
<Alt>+<F7>	Exit On-Screen User Interface and turn OFF AutoSkip
<F12>	Toggle Selection Menu sorting (by Name or Channel ID)
<Esc>	Exit on-screen user interface and return to normal computer operation at the last channel selected. If SCAN is set ON, the system will AutoScan according to parameters set in the Configuration Menu

Appendix D: MasterConsole II Configurations

Programming MasterConsole II at Power Up

MasterConsole II Product Design Background and Considerations

- User connection and operation of MasterConsole II is through the unit's local KVM port (marked Keyboard, Monitor, Mouse - Din 6F, HD15F, Din 6F) on the back panel of each MasterConsole II.
- For operation, a console-keyboard, monitor and mouse-plugs into the local KVM port. MasterConsole II includes front panel buttons as well as an integrated On-Screen User Interface for switching and other operations.
- The On-Screen User Interface is activated through a console keyboard and facilitates operation of MasterConsole II with on-screen menus and commands.
- In a one-tier configuration, the console operates the all connected computers. The KVM port is called first-tier ports, which means that they have an active On-Screen User Interface for console operation.
- In a two-tier configuration, one or more MasterConsole II second-tier units are cascaded from the base unit. This is accomplished by connecting MasterConsole II computer cable from the base unit to the KVM port of the second-tier unit. The base unit's local KVM port and remote access port are first-tier ports with an active On-Screen User Interface; and the base unit's on-screen menus include the names of all the computers accessible from the base unit's console. This way, the base unit's console can access and operate all MasterConsole II units and all connected computers. For proper operation, the user must see only the base units On-Screen User Interface menus from the base unit console. To accomplish this, the On-Screen User Interface at the port by which the second-tier unit is connected must be deactivated, so that the base unit console can access and operate all connected computers. A port with a deactivated On-Screen User Interface and is called a second-tier port.

Programming MasterConsole II

Each MasterConsole II is programmed at the factory as a base tier unit. To modify the factory setting, a MasterConsole II unit can be programmed as a second-tier unit by holding down the #2 button on the front panel at power up for a minimum of 3 seconds.

MasterConsole II Configuration Diagrams

Basic MasterConsole II One-Tier Configurations

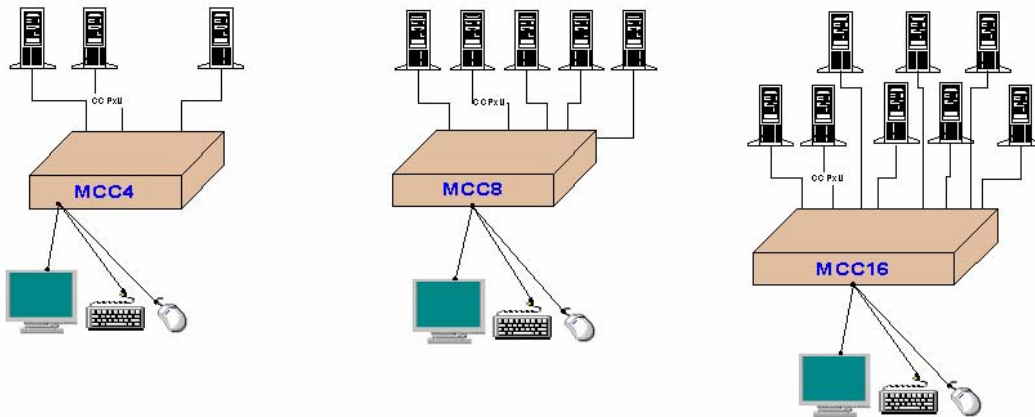

MasterConsole II Basic Configurations of 2 to 16 Computers

Figure 30 Basic One-Tier Configurations

MasterConsole II Two-Tier Configuration with Remote Access Kit

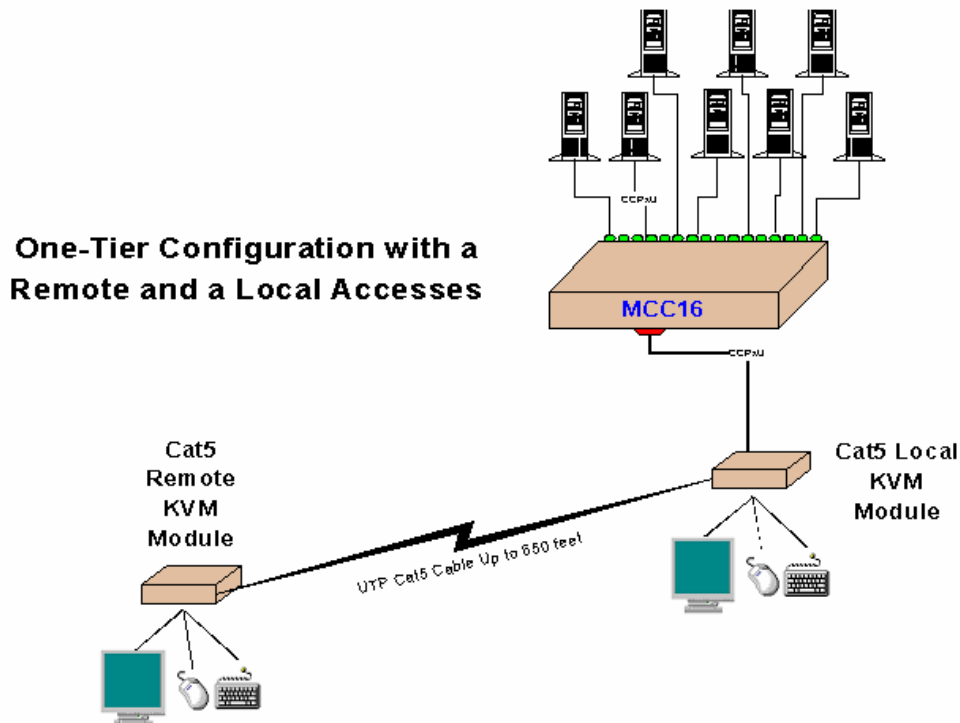

Figure 31 One-Tier with Remote Access Kit

MasterConsole II Two-Tier Configuration

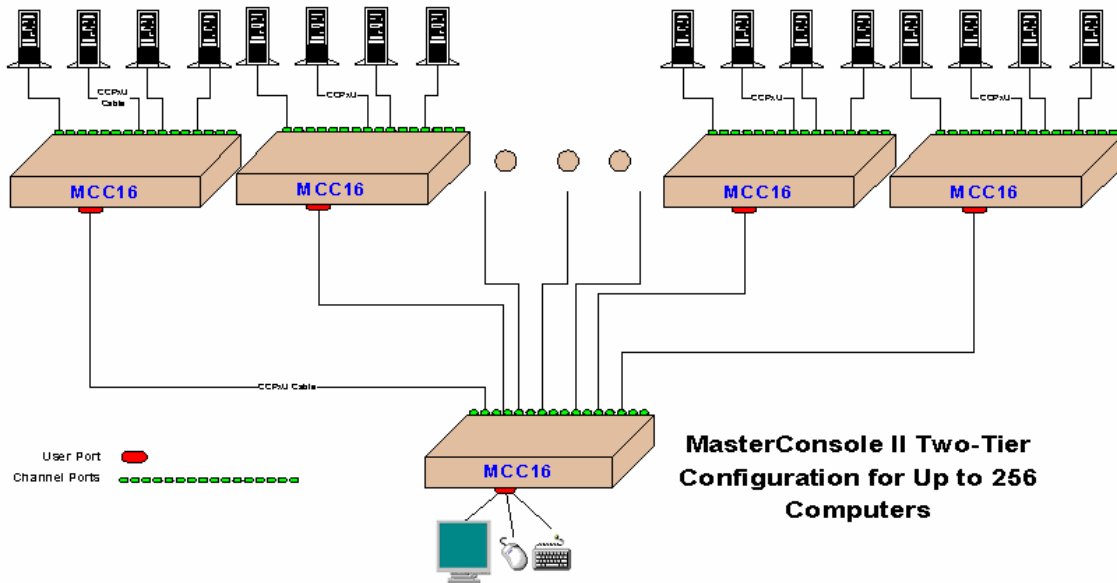

Figure 32 Two-Tier Configuration of up to 256 Computers

MasterConsole II Two-Tier Configuration with MasterConsole P Model

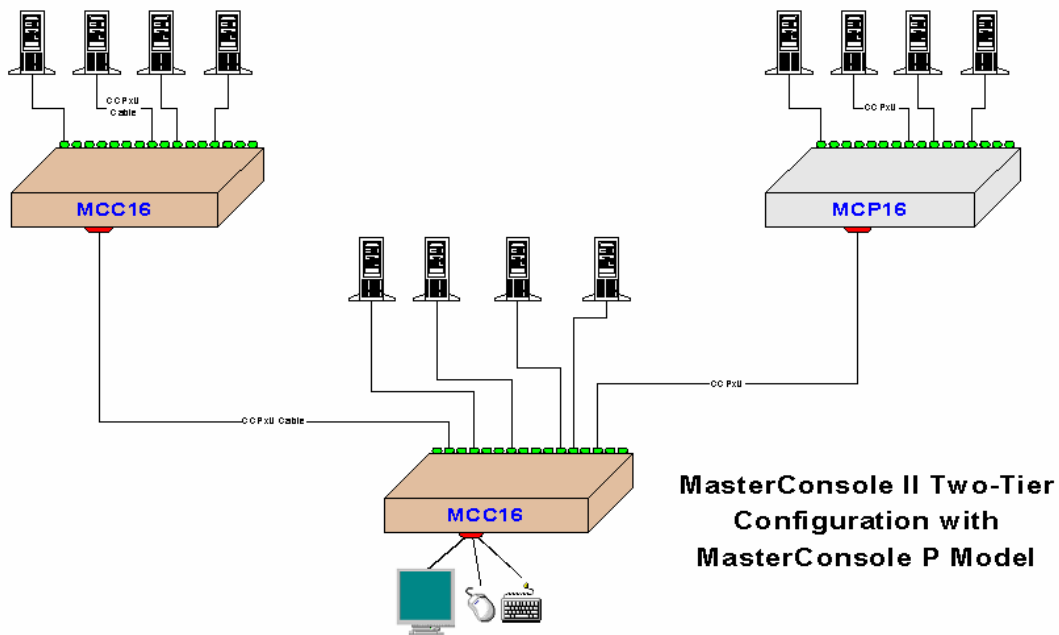

Figure 33 Two-Tier Configuration with MasterConsole P Model

MasterConsole II Two-Tier Configuration with Satellite Unit

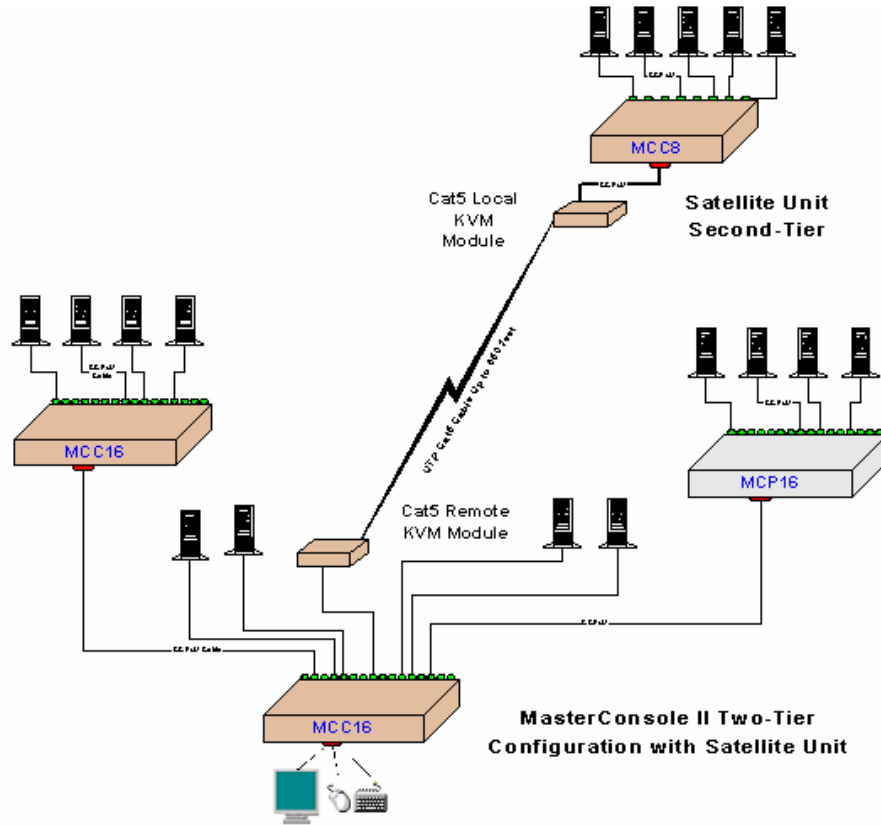

Figure 34 Two-Tier Configuration with Satellite Unit

Appendix E: Glossary

TERM	DEFINITION
Administration Menu	Used to restrict access to MasterConsole II; toggle Security ON/OFF and to change Administrator's Password and up to five User Passwords.
Administration Password	The only Password with access to the Administration Menu, through the Administration password prompt.
AutoScan	When activated, MasterConsole II automatically cycles through channels, displaying each computer's video for a specified period.
AutoSkip	When activated, channel selection is restricted to active channels.
Base Unit	MasterConsole II unit to which devices (computers and / or other MasterConsoles) are connected in a two-tier configuration.
Channel	The 25-pin connector by which a device is connected to MasterConsole II.
	Active: A channel is active when a powered ON device is connected to it.
	Inactive: A channel is inactive when there is no device connected to it, or if the connected device is powered OFF.
Channel ID	The specific Channel number to which a device is connected.
Configuration	One-Tier: Computers are connected to a single MasterConsole II unit.
	Two-Tier: A mix of devices (computers and MasterConsole units) is connected to a base MasterConsole unit.
Configuration Menu	Used to specify MasterConsole II configuration and operation parameters.
Device	A computer or a MasterConsole unit connected to a MasterConsole II channel.
Device Field	In the Configuration Menu, specifies the type of device connected to each channel of a base MasterConsole II unit.
Edit Names and Scan Rate Menu	Channel-Specific Scan Rates.
Green Mode	A field in the Configuration Menu used to toggle the PowerSave feature ON/OFF.
Hot Key	Used to activate On-Screen User Interface. (To activate On-Screen User Interface, press the hot-key twice rap
ID Display	The display shown on the monitor to identify the currently selected channel
Key	Left-hand column in the Selection Menu; lists the key numbers (a sequence of numbers) for the channels listed on that page. To quickly select a channel, press its Key number when the Selection Menu is displayed.
KVM Port	The Keyboard, Monitor, and Mouse connectors on the back of the MasterConsole II unit.
Menu	An On-Screen User Interface display.
Menu F Keys	Function keys used to access On-Screen User Interface menus while On-Screen User Interface is activated.
Mode	Field in the Configuration Menu; can be set to either Global or Individual. See also Scan Rate.
Name	A user-assigned label (up to eight characters) for a device connected to a MasterConsole II channel.

TERM	DEFINITION
On-Screen User Interface (OSUI)	Series of Menus displayed on the monitor that can be used, through keystrokes, to operate MasterConsole II. All keystrokes are captured and interpreted as MasterConsole II commands.
PowerSave	Allows a properly equipped monitor to operate in low-energy mode.
Remote Console	Keyboard, monitor, and mouse plugged into the Remote access kit.
	Cat5 Remote KVM Module: Optional Remote Unit that connects to the MasterConsole II to provide additional access to connected computers up to 650' away using Cat5 UTP Cable.
	Cat5 Remote KVM Port: The Keyboard, Monitor, and Mouse ports on the back of the Cat5 Remote KVM Module unit.
Satellite Unit	Second-tier MasterConsole II located more than 30 feet from the base unit and connected through its Remote Access Kit.
Scan	Front panel button and On-Screen User Interface function used to activate AutoScan.
Scan Rate	The duration (in seconds) a channel's computer is to remain displayed on the monitor when AutoScan is activated.
	Global Scan Rate: Scan rate is the same for all computers, if the Mode field in the Configuration Menu is set to Global.
	Channel-Specific (Individual) Scan Rate:: Scan rate specified for each computer during the Scan cycle, if the Mode field in the Configuration Menu is set to Individual. Channel-specific scan rates can be set in the Edit Names and Scan Rate Menu.
Security	When activated, and the system remains idle for a period of time, the next user must enter an authorized User Password to establish access.
Selection Menu	Used to select a computer.
Sorting	Order of the channels listed in Selection Menu; either by Channel ID or by Name.
Time Out	the length of time that the system can remain idle (that is, since the last keyboard/mouse or front panel operation) before the next user must enter an authorized User Password to establish access.
User Password	Enables access to the system after Time Out.

Appendix F: Troubleshooting

PROBLEM	SOLUTION
No power.	a. Check power cord. b. Make sure power switch is turned ON. c. Check cable connection from PC to MasterConsole II.
No video display for one or all computers.	a. Check video cable's connection to the PC. b. Check the monitor and PC: Turn off power to MasterConsole and the PCs. Connect the monitor to the PC directly, boot the PC, and make sure the monitor has the proper display. If it does not, the problem is either with your PC, or the monitor is not compatible with your PC. If it does display, continue to Troubleshooting #3.
The monitor cannot correctly display the video output from some of the PCs.	a. The monitor probably does not match the video outputs. If the monitor is a single mode type VGA, all PCs must have the same type of video output. b. (Note: this problem occurs most often with some IBM PS/2s and IBM 63xx, 85xx, and 95xx monitors.) The intelligent type display card outputs video signals based on the monitor ID-pin setting in the connector of the monitor cable. If the ID-pin setting is correct, the monitor at MasterConsole may have no display, become monochrome instead of color, or become unstable. If this is the case, you will need to provide a proper ID-pattern to the display card. Call Raritan Computer for help if necessary.
All PCs powered up without keyboard error, but the keyboard at MasterConsole II has no control (cannot input to any PC).	a. Make sure the keyboard is connected firmly into MasterConsole II. Disconnect and reconnect keyboard. b. Replace keyboard. (MasterConsole II allows hot re-connection of keyboard at its Keyboard port.) c. In a two-tier configuration, check that the MasterConsole II with the keyboard connected is the base unit.
Repeated "KB ERROR" at power-up of PC.	a. The keyboard cable from the PC to MasterConsole II is loose. Secure the connection and power up the PC again. b. If the problem occurs after MasterConsole II has been installed for a period of time, and occurs on PCs that have previously worked with MasterConsole II, then some components are out of order. Verify that the PC works with the keyboard when connected directly. Then contact your dealer or Raritan Computer for service.
After a period of trouble-free operation, the keyboard attached to MasterConsole II locks (unable to input keystrokes) when a particular PC is selected, but works normally when other PCs are selected.	a. The most likely cause of the problem is either a voltage "spike" (increase) or a "brown out" (decrease) in the power supply, which would cause the microprocessors in MasterConsole II to malfunction. A short-term solution to the problem is to try to recover operation by turning the MasterConsole II power switch off and on. Then, if necessary, restart all PCs. The long-term method of avoiding this problem is to power MasterConsole from a UPS. b. Check keyboard connection.
Repeated "MOUSE INSTALLATION FAILURE" at power-up of PC.	a. The mouse cable from the PC to MasterConsole II is loose. Secure the connection and power up again. b. If the problem only occurs to new PCs which are being added to the system, the firmware in the KVM (MasterConsole II internal mouse emulator) may need to be upgraded to a later version to be compatible with newer PCs. Contact your dealer or Raritan Computer for Service.
After a period of trouble-free operation, the mouse attached to	a. Try to identify if the problem is originating from the PC by reconnecting the PC to a different channel with a different cable. Then power up the PC. If the problem is not with the cable or with the

PROBLEM	SOLUTION
MasterConsole II locks (unable to control mouse functions) when a particular PC is selected, but works normally when other PCs are selected.	<p>specific channel, then connect the mouse directly to the PC. If the problem persists, then the PC's mouse port is out of order. Otherwise, contact your dealer or Raritan Computer.</p> <p>b. If the problem occurs after MasterConsole II has been installed for a period of time, and occurs to PCs that have previously worked with MasterConsole II, then some components are out of order. Contact your dealer or Raritan Computer for service.</p>
Unit does not operate in On-Screen User Interface.	Replace keyboard. On-Screen User Interface works only with PS/2 or extended AT style keyboards.
Unable to select channel.	Scan function is active; press the Scan button once to toggle Scan OFF so the light next to the button is off.